

## Achtung

attention – attention

Kinder können sich in den Schlingen von Schnüren, Ketten oder Gurten zur Bedienung von Sicht- und Sonnenschutzeinrichtungen verfangen oder sich Schnüre um den Hals wickeln und sich unter Umständen dadurch strangulieren. Schnüre, Ketten und Gurte sind außer Reichweite von Kindern zu halten, um Verwicklungen und Strangulierungen zu vermeiden. Betten, Kinderbetten und Möbel sind entfernt von Bedienungen für Sicht- und Sonnenschutzeinrichtungen aufzustellen.

*Children can get caught in the loops of cords, chains or straps that operate window coverings or they can wrap cords around their necks and strangle thereby. Keep cords, chains and straps out of reach of children to avoid entanglement and strangulation. Move beds, cots and furniture away from window covering operations.*

*Les enfants peuvent se prendre dans cordons, chaînettes ou courroies qui actionnent les stores de protection solaire et visuelle ou ils peuvent enrouler les cordons autour leur cou et ainsi s'étouffer. Maintenez les cordons, chaînettes et courroies hors de portée des enfants pour éviter de s'étouffer ou de s'emmêler. Placez les lits, berceaux et meubles à l'écart des manipulations des stores de protection solaire et visuelle.*

Entspricht EN 13120  
according to EN 13120 – selon EN 13120

## Plissees

pleated blinds – stores plissés

# DF20

## Montage- und Bedienanleitung

assembly and operating instructions  
notice de montage et mode d'emploi

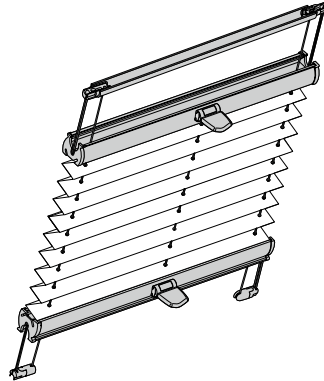

799.028.523

01 / 2012  
Technische Änderungen bleiben vorbehalten  
subject to technical change  
sous réserve de modifications techniques

## A Montage

fixation – montage

→ **Bitte nur beiliegende Schrauben verwenden!**  
Please use enclosed screws only! – Se servir exclusivement des vis jointées!

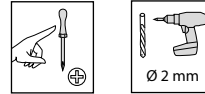

### VORBEREITUNG

PREPARATION – PRÉPARATION

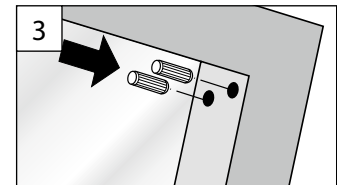
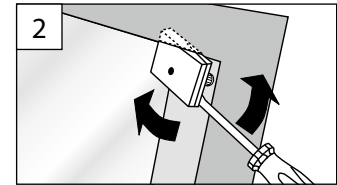
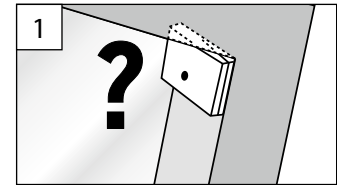
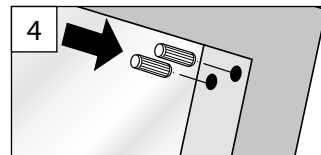
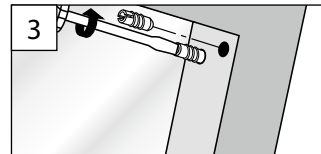
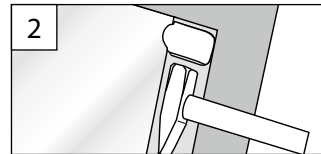

1

# SPANNSCHUH

TENSION CORD BRACKET - SUPPORT DE CORDON DE TENSION

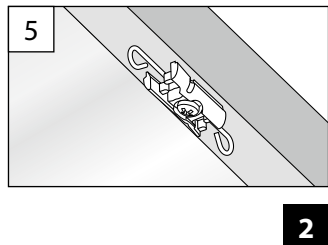
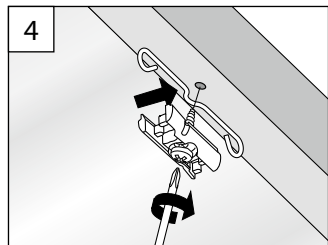
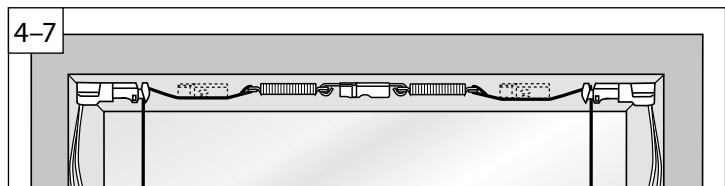
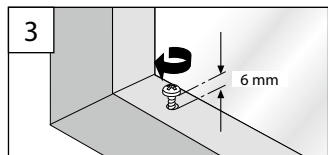
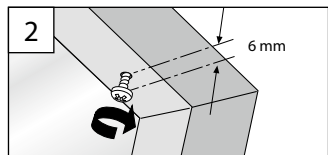
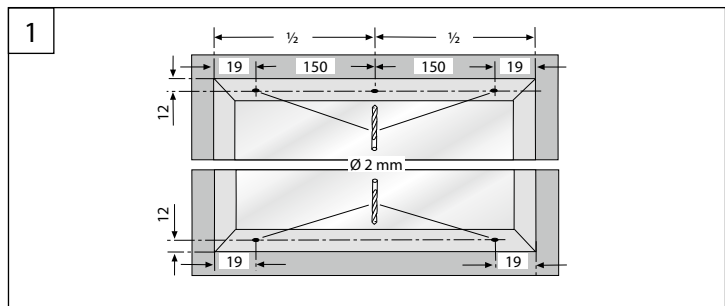

2

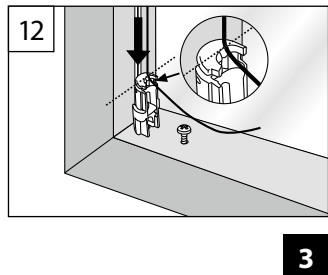
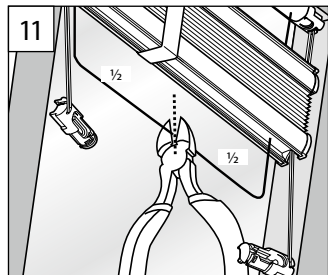
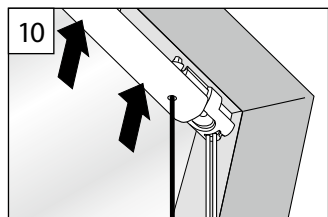
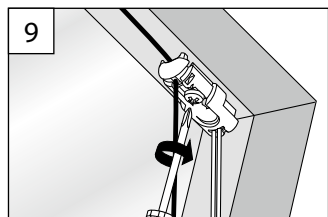
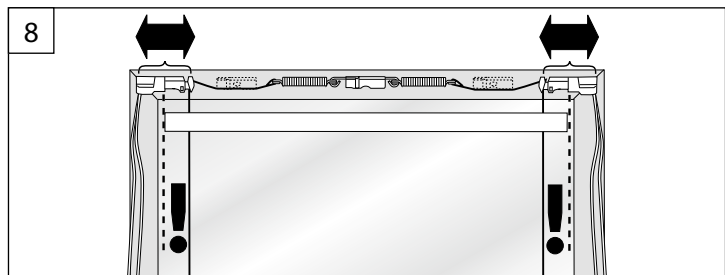
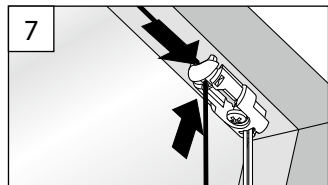
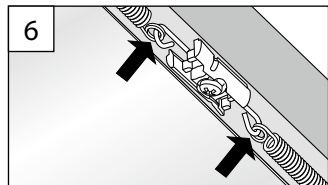

3

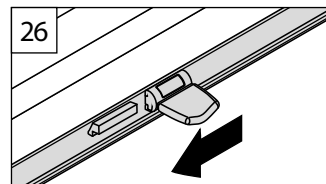
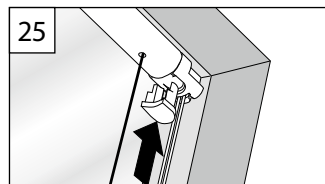
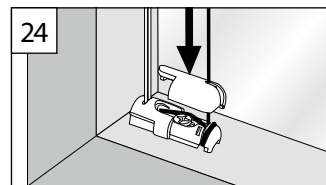
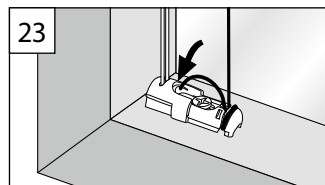
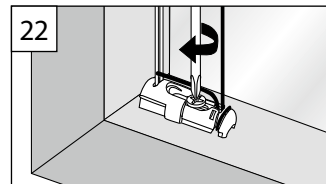
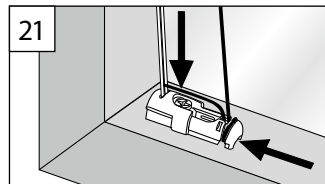
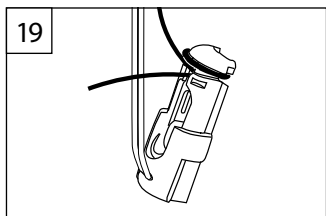
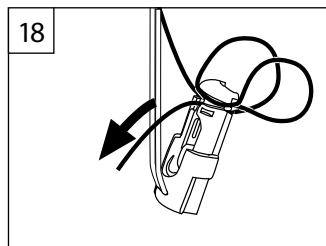
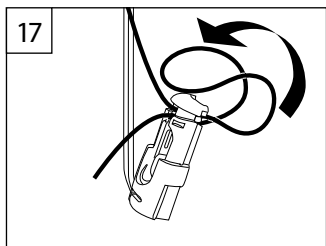
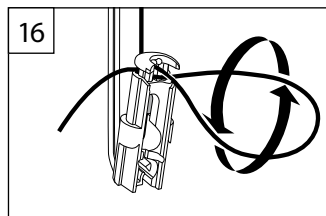
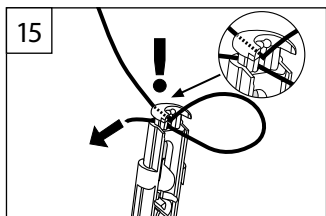
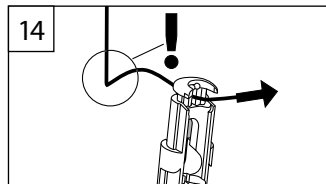
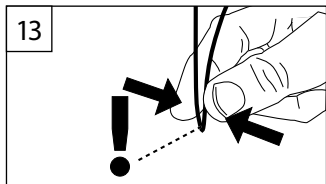

**BRAAS ERGÄNZUNG**  
BRAAS ENDORSEMENT - COMPLÉMENT BRAAS

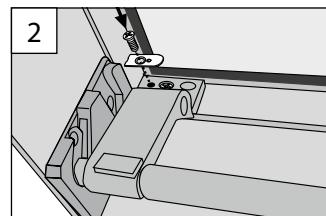
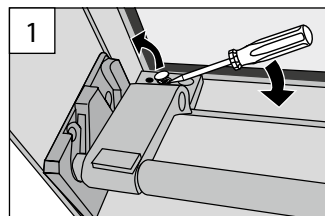

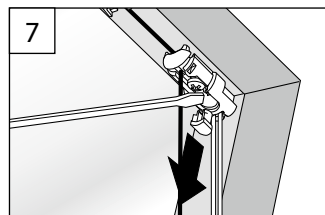
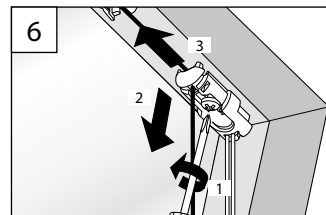
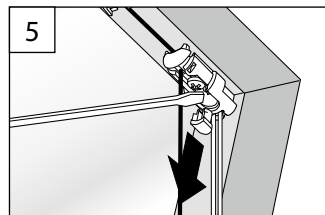
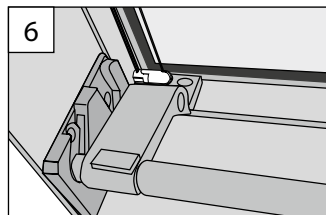
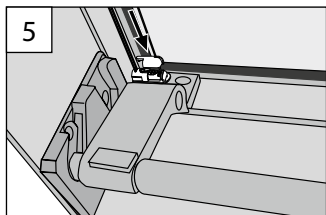
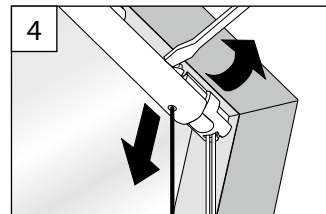
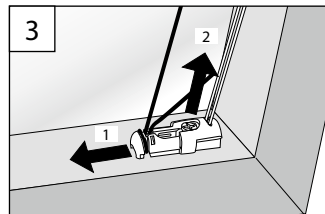
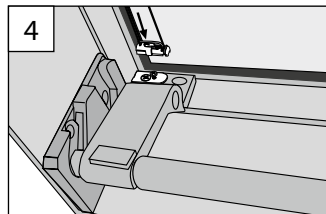
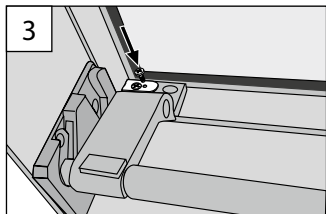

## B Demontage

dismantling - démontage

### SPANNSCHUH

TENSION CORD BRACKET - SUPPORT DE CORDON DE TENSION

