

Achtung
attention – attention

Kinder können sich in den Schlingen von Schnüren, Ketten oder Gurten zur Bedienung von Sicht- und Sonnenschutzeinrichtungen verfangen oder sich Schnüre um den Hals wickeln und sich unter Umständen dadurch strangulieren. Schnüre, Ketten und Gurte sind außer Reichweite von Kindern zu halten, um Verwicklungen und Strangulierungen zu vermeiden. Betten, Kinderbetten und Möbel sind entfernt von Bedienungen für Sicht- und Sonnenschutzeinrichtungen aufzustellen.

Children can get caught in the loops of cords, chains or straps that operate window coverings or they can wrap cords around their necks and strangle thereby. Keep cords, chains and straps out of reach of children to avoid entanglement and strangulation. Move beds, cots and furniture away from window covering operations.

Les enfants peuvent se prendre dans cordons, chaînettes ou courroies qui actionnent les stores de protection solaire et visuelle ou ils peuvent enrouler les cordons autour leur cou et ainsi s'étouffer. Maintenez les cordons, chaînettes et courroies hors de portée des enfants pour éviter de s'étouffer ou de s'emmêler. Placez les lits, berceaux et meubles à l'écart des manipulations des stores de protection solaire et visuelle.

Entspricht EN 13120
according to EN 13120 – selon EN 13120

Plissee
pleated blinds – stores plissés

VSR11, VSR12, VSR13

Montage- und
Bedienanleitung
assembly and operating instructions
notice de montage et mode d'emploi

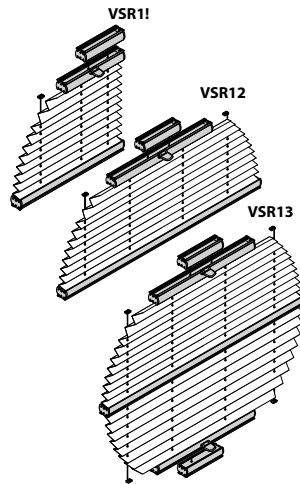

799-028 505

02 / 2012
Technische Änderungen bleiben
vorbehalten
subject to technical change
sous réserve de modifications techniques

A Montage
fixation – montage

→ **Bitte nur beiliegende Schrauben verwenden!**
Please use enclosed screws only! – Se servir exclusivement des vis jointes!

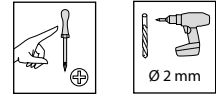

DECKENCLIP
CEILING CLIP – CLIP PLAFOND

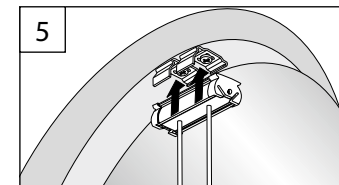
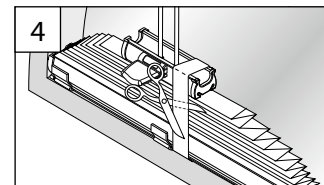
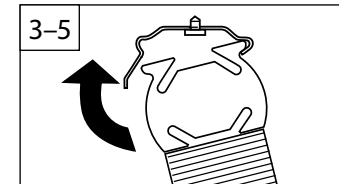
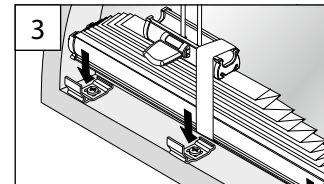
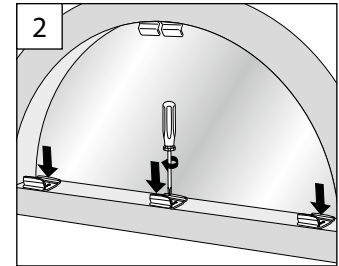
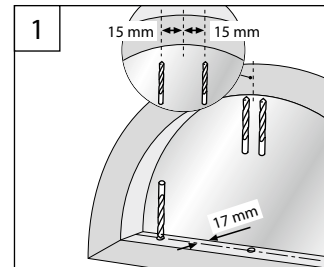

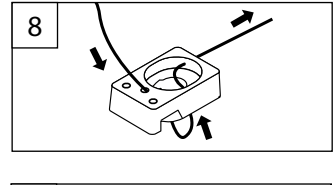
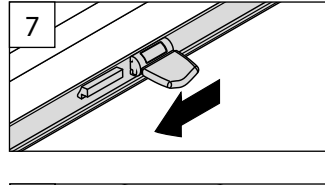
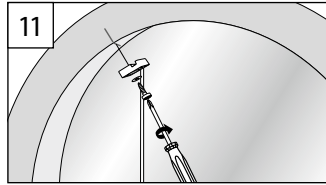
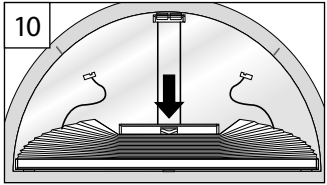
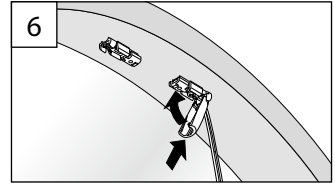
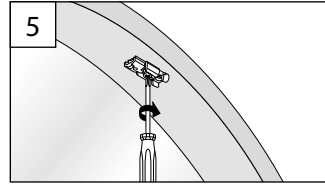
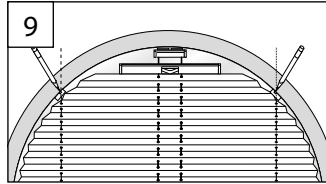
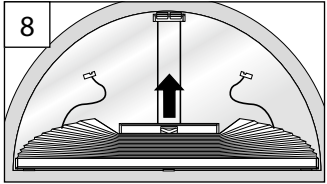
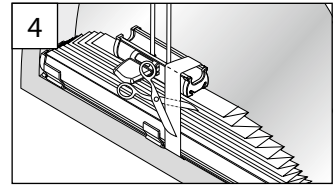
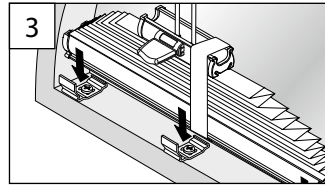
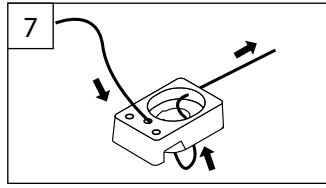
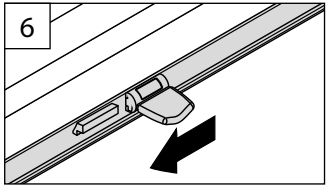

SPANNSCHUH

TENSION CORD BRACKET - SUPPORT DE CORDON DE TENSION

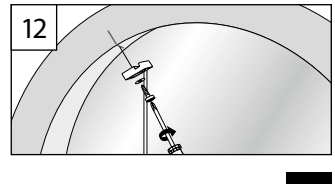
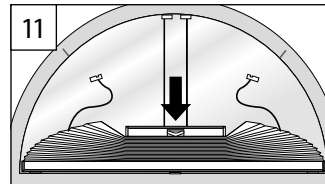
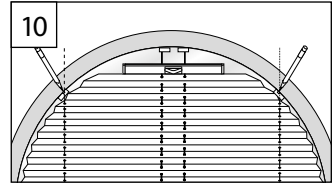
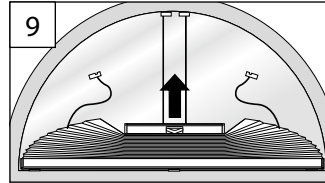
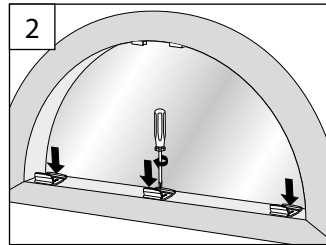
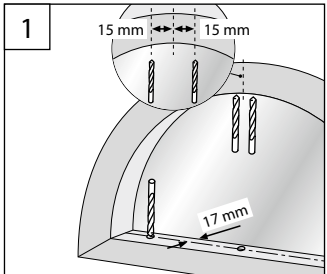

WANDWINKEL

WALL FIXING BRACKET – SUPPORT MURAL

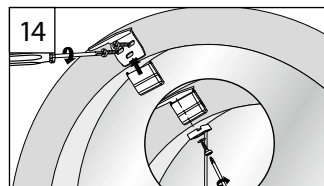
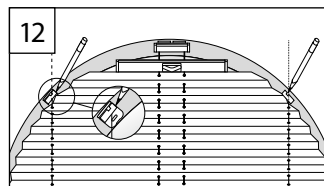
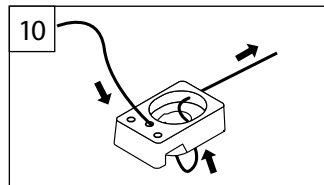
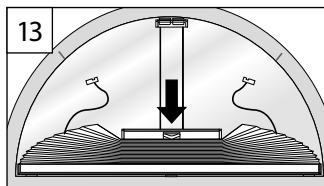
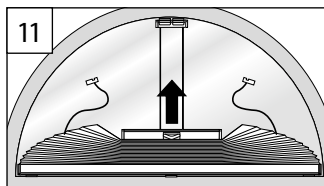
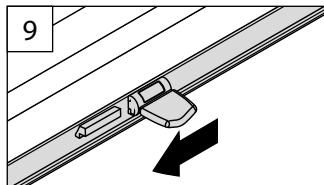
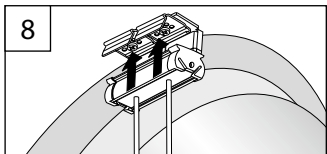
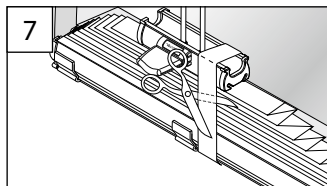
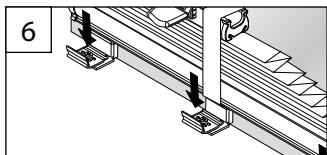
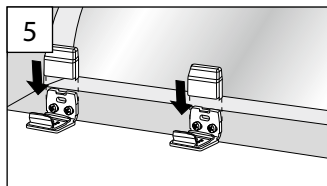
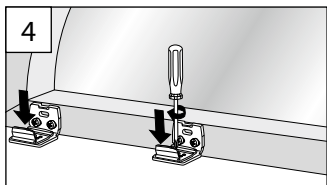
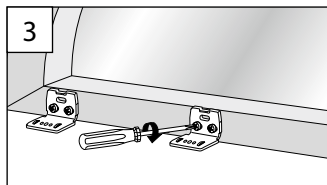
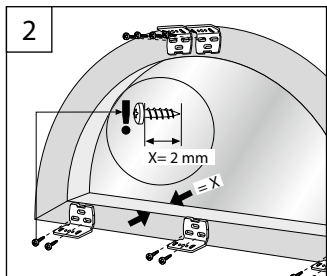
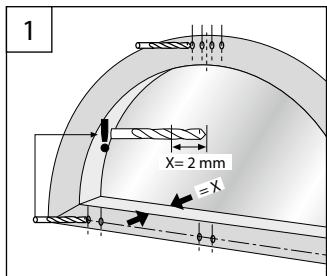

B Demontage

dismantling – démontage

SPANNSCHUH

TENSION CORD BRACKET – SUPPORT DE CORDON DE TENSION

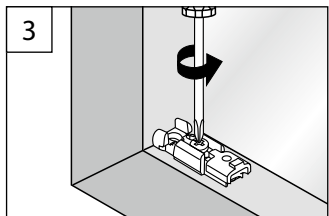
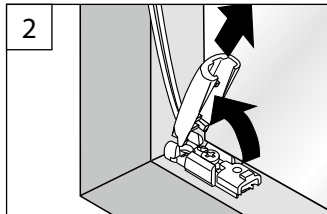
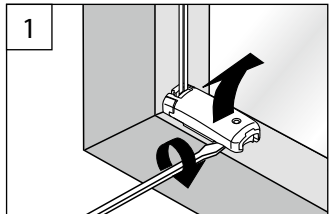

DECKENCLIP

CEILING CLIP – CLIP PLAFOND

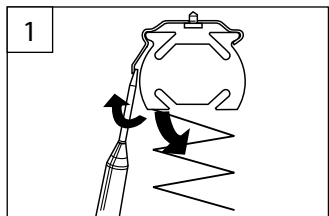

C Bedienung

operation – manipulation

