

DECKENCLIP

CEILING CLIP – CLIP PLAFOND

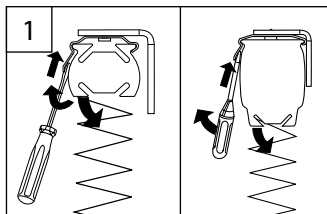

**PL11,
PLK13 (Kurbel)**

PLK13 (crank) – PLK13 (manivelle)

PLE12 (Motor)

PLE12 (motor) – PLE12 (moteur)

Montage- und
Bedienanleitung

Assembly and operating instructions

Notice de montage et mode d'emploi

PL11

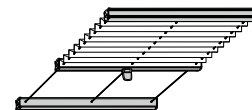

PLK13 (Kurbel)

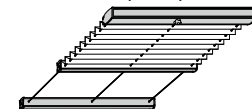

PLE12 (Motor)

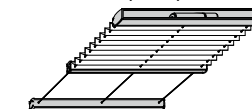

10 / 2014 technische Änderungen
bleiben vorbehalten



A Montage

Fixation – Montage

→ **Bitte nur beiliegende Schrauben verwenden!**

Please use only the enclosed screws! - Veuillez utiliser seulement les vis jointes!



Standard
Standard
Standard



Wabe
Honeycomb
Alvéole

DECKENCLIP

CEILING CLIP – CLIP PLAFOND

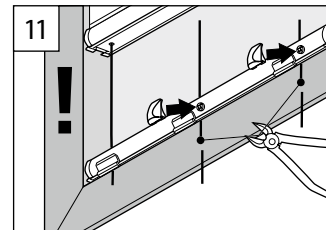
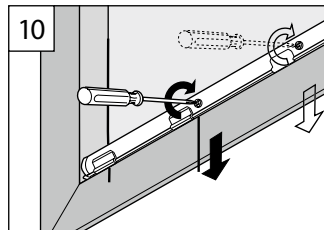
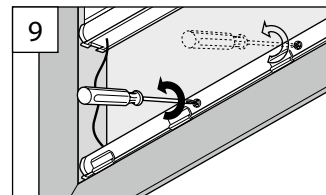
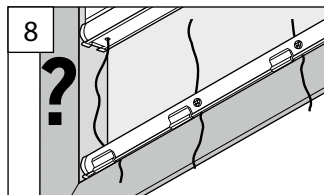
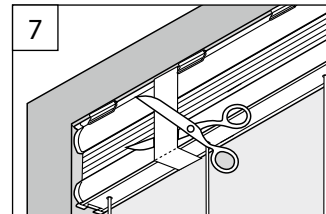
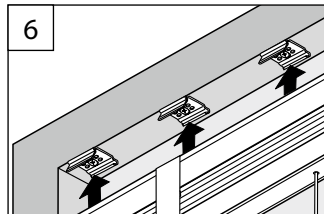
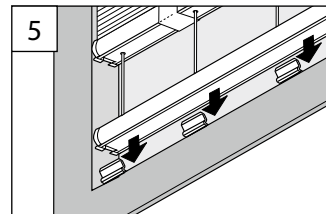
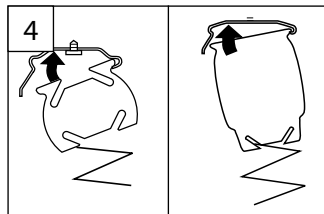
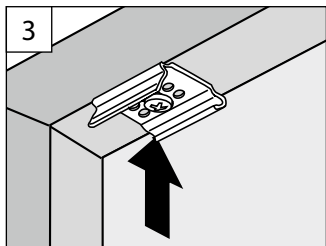
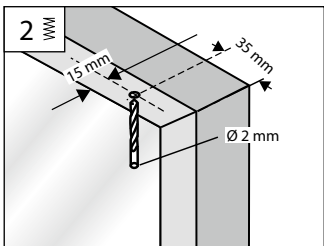
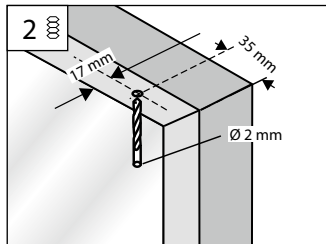
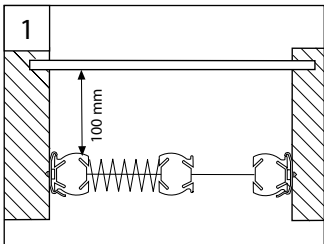

1

2

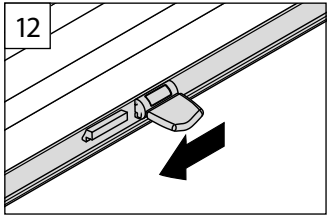

DECKENCLIP / WANDWINKEL

CEILING CLIP / WALL FIXING BRACKET – CLIP PLAFOND / SUPPORT MURAL

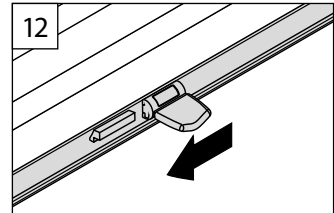
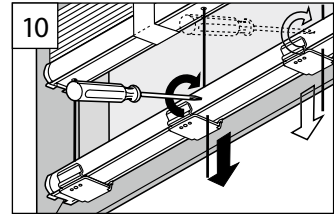
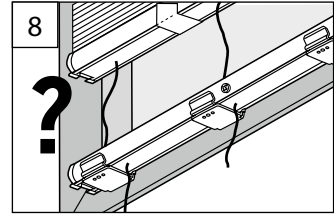
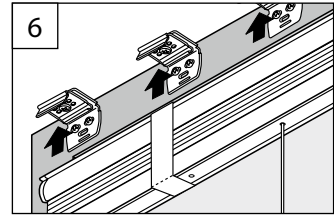
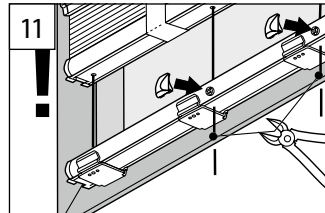
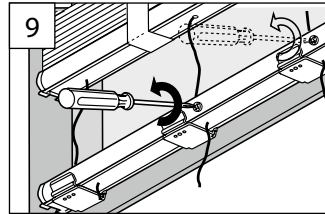
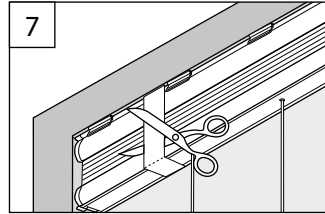
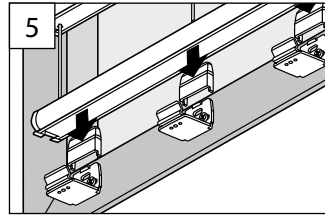
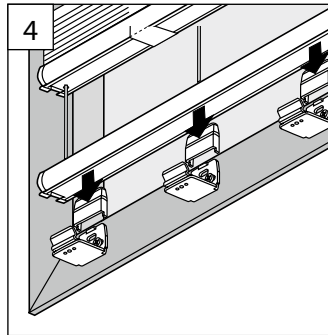
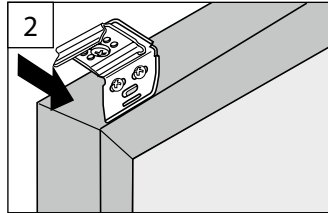
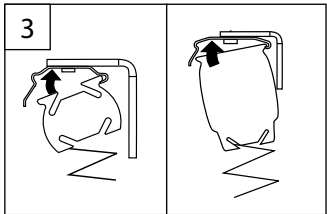
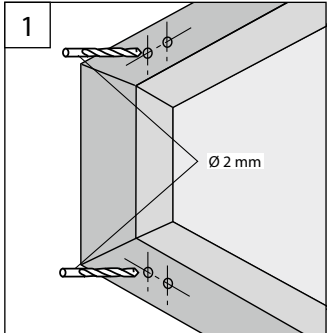

B Bedienung

Operation – Manipulation

