

# VS1, VS3, VS SD

Montage- und  
Bedienanleitung  
*Assembly and operating instructions*  
*Notice de montage et mode d'emploi*

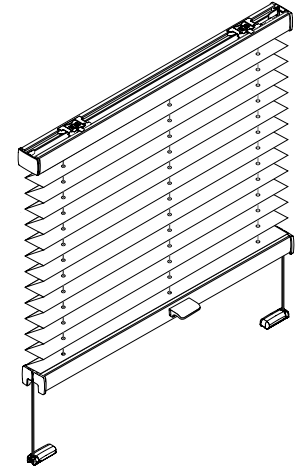

02 / 2021

technische Änderungen bleiben  
vorbehalten  
*subject to technical change*  
*sous réserve de modifications techniques*

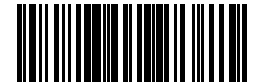

04046046444572

# A Montage

Fixation – Montage

→ **Bitte nur beiliegende Schrauben verwenden!**

Please use only the enclosed screws! – Veuillez utiliser seulement les vis jointes!

## DECKENCLIP / SPANNSCHUH

CEILING CLIP / TENSION CORD BRACKET

CLIP PLAFOND / SUPPORT DE CÂBLES

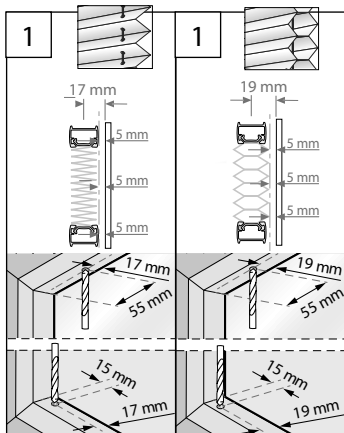
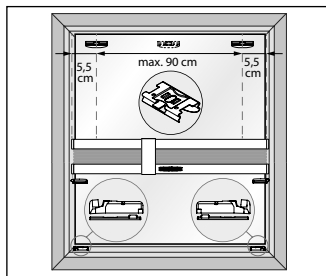
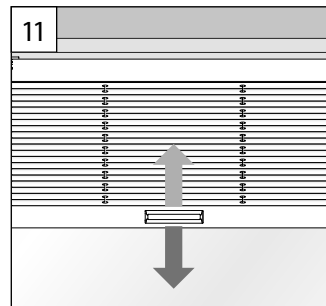
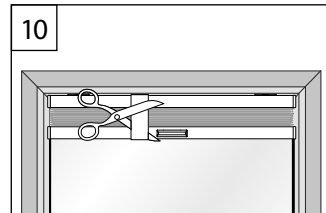
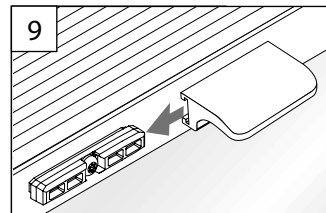
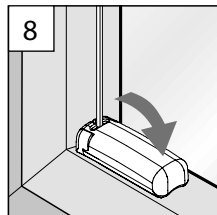
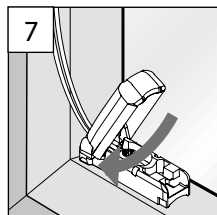
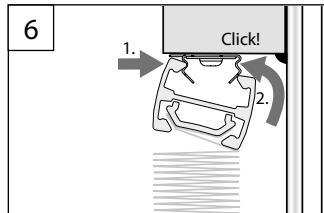
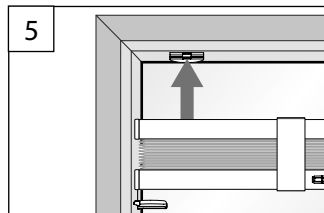
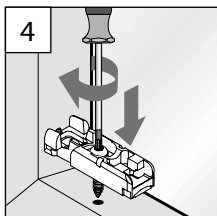
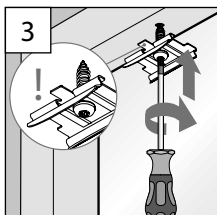
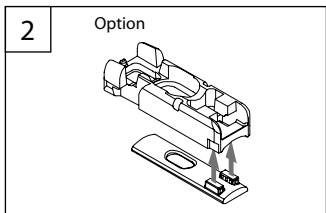
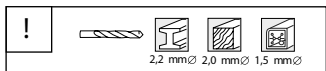

1

2

# DECKENCLIP / WANDWINKEL

CEILING CLIP / WALL FIXING BRACKET – CLIP PLAFOND / SUPPORT MURAL

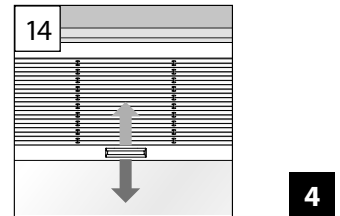
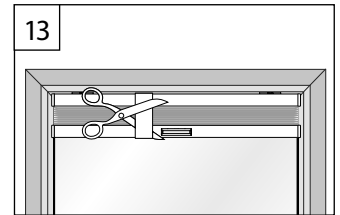
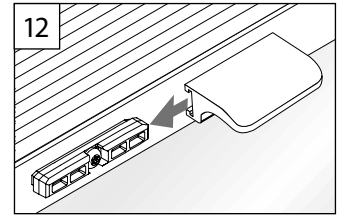
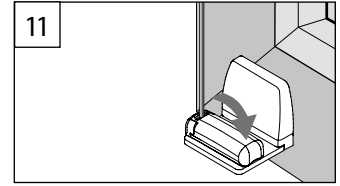
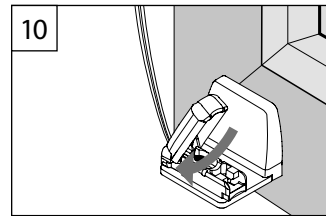
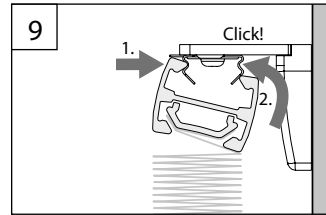
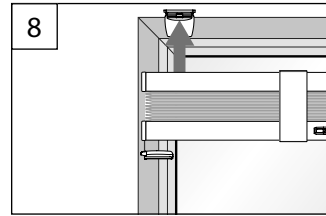
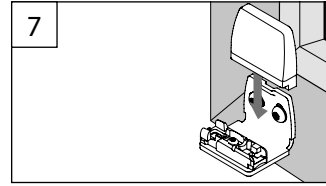
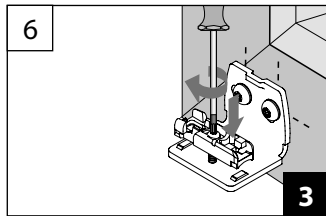
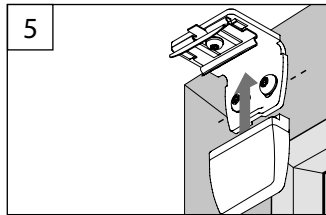
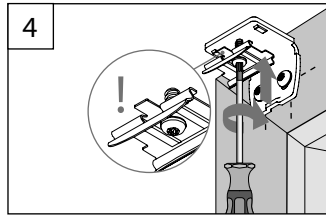
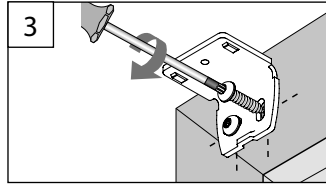
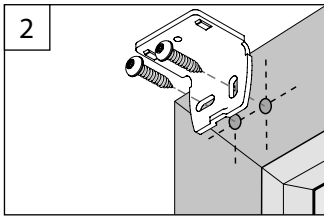
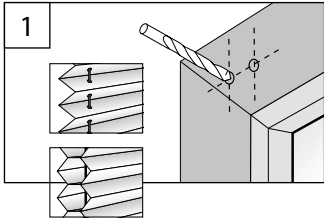
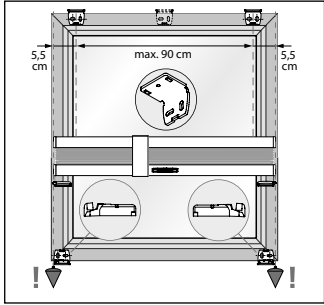

3

4

## B Demontage

Dismantling – Démontage

### SPANNSCHUH

TENSION CORD BRACKET – SUPPORT DE CÂBLES

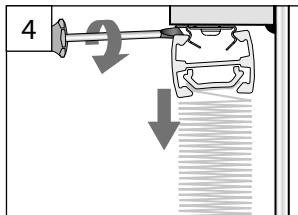
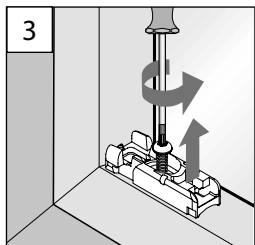
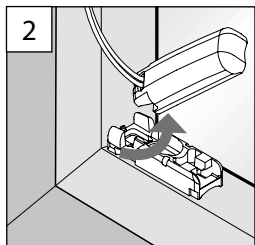
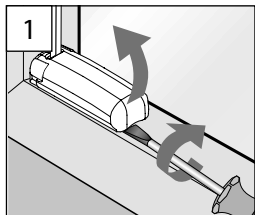

### WANDWINKEL

WALL FIXING BRACKET – SUPPORT MURAL

